

# Harmony Hub — we build, you relax!

**Harmony Hub** is a manufacturing company that has been successfully operating in the Moldovan market for over 5 years, specializing in the design and construction of modular frame structures. All our projects are based on a **metal frame**, which ensures the strength, durability, and precise geometry of the modules. We are consistently developing the direction of modular construction, creating solutions for private, commercial, and tourism projects. Today, Harmony Hub implements: modular and frame residential houses; mirrored frame houses; modular outdoor saunas; modular and individual garages for cars and motorcycles; advertising and commercial modules; non-standard frame structures based on client tasks. The company's key advantage is a **full production cycle**. All stages, from design and frame manufacturing to assembly, insulation, finishing, and final preparation of the product, are performed at our own production facility in Chisinau. We fully control the quality and deadlines without outsourcing key processes. The Harmony Hub team consists of 10 specialists with an engineering approach and practical experience. We use only proven materials and create functional, reliable, and ready-to-use modular solutions. Harmony Hub is a production where every structure is created with our own hands and with full responsibility for the result.

# Features and Model Options- "Hub 220"

**Hub 220** is a compact and stylish modular sauna, ideally suited for private homes and small plots. The modern **Glass-front design** with panoramic glazing and natural wood finish creates a sense of comfort, light, and visual space. Key advantages: Glass-front panoramic glazing; fully ready for use; natural finishing materials; fast installation

Technical characteristics:

dimensions: 220 × 220 × 230 cm;

weight: about 1300 kg

## Description of the sauna's basic equipment:

Metal frame, wooden battening, benches and interior walls made of lime wood, LED lighting of backrests and shelves, adjustable ventilation system, wooden floor slats for a comfortable stay, insulation—**Sweetondale basalt wool (non-combustible)**\PIR, facade glazing made of ESG safety glass 8 mm thick with a black enamelled frame, floor covering—porcelain stoneware. The wooden facade is treated with an antiseptic layer and two layers of facade lacquer from the manufacturer Renner (Italy).

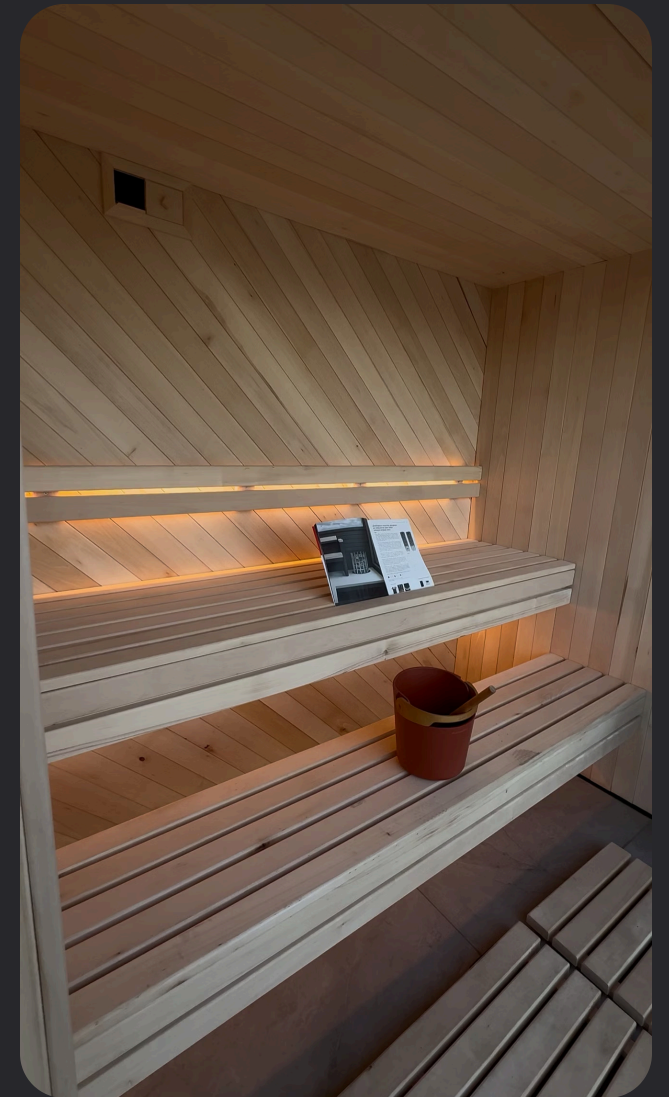

This sauna can be executed in different versions depending on the client's wishes.

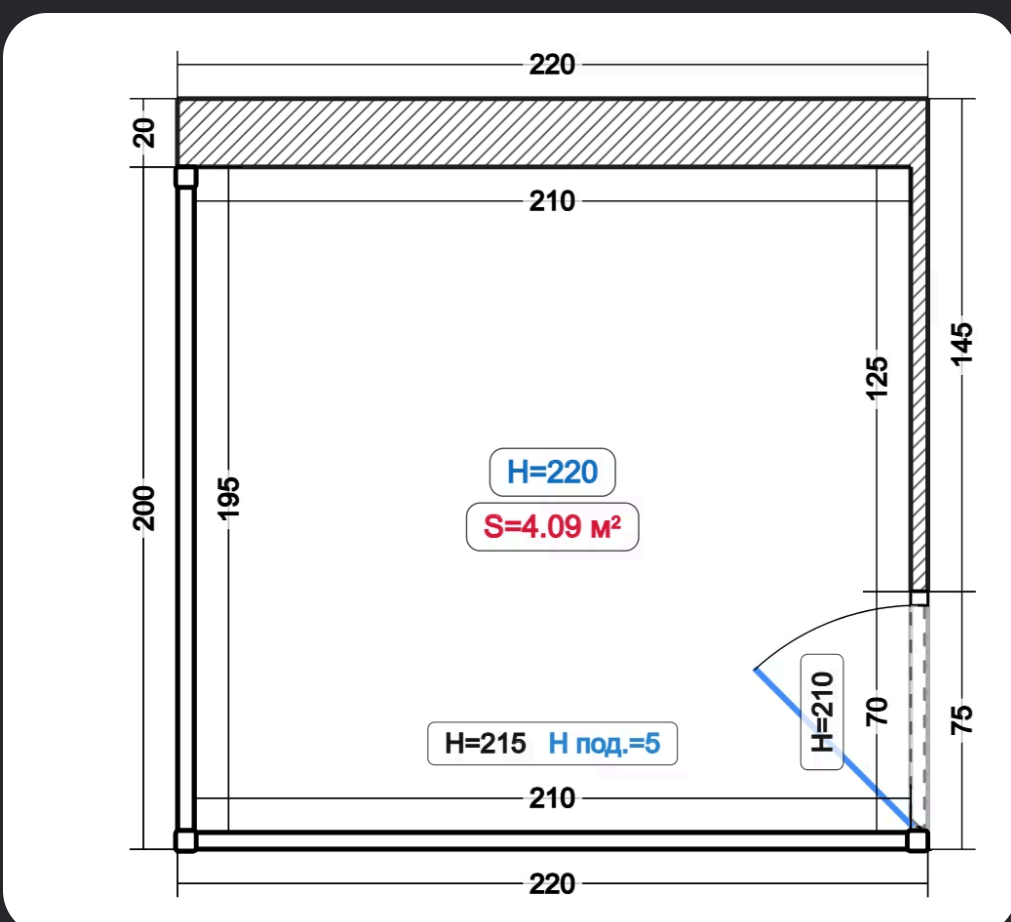
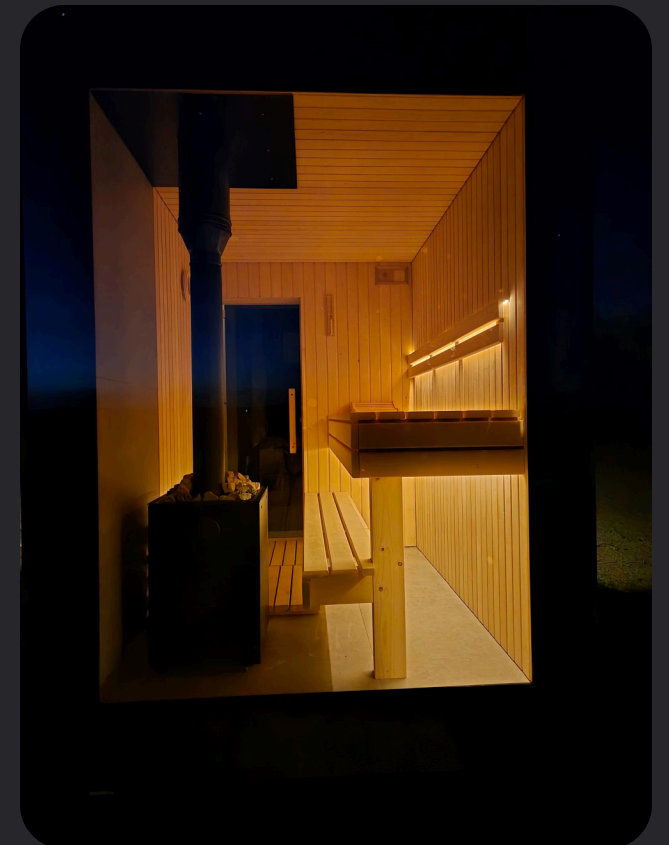

Basic plan

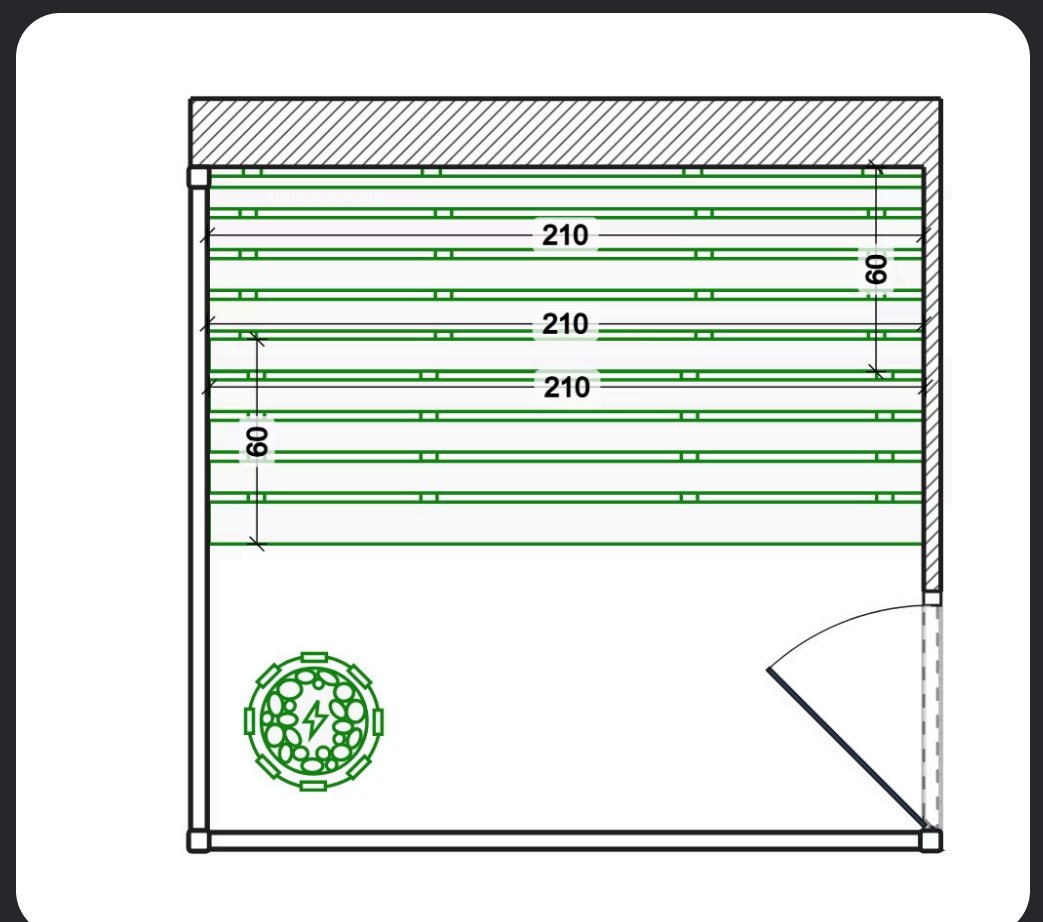

Layout of wooden furniture and the stove

Basic sauna price "HUB 220" - 10800 Euro (EXW Chisinau)

# Features and Model Options- "Hub 322"

**Hub 322** is a balanced solution for those who value more space and comfort without a significant increase in the area occupied by the plot. It is suitable for both private homes and tourism projects. Key advantages: increased internal area; panoramic glazing; possibility of installing a shower system; flexible layout options.

Technical characteristics:

dimensions: 322 × 230 × 230 cm

weight: about 1500 kg

## Description of the sauna's basic equipment:

Metal frame, wooden battening, benches and interior walls made of lime wood, LED lighting of backrests and shelves, adjustable ventilation system, wooden floor slats for a comfortable stay, insulation—Sweetondale basalt wool (non-combustible)\PIR, facade glazing made of **ESG safety glass 10 mm thick** with a black enamelled frame, floor covering—porcelain stoneware. The wooden facade is treated with an antiseptic layer and two layers of facade lacquer from the manufacturer Renner (Italy).



This sauna can be executed in different versions depending on the client's wishes



Error uploading image.

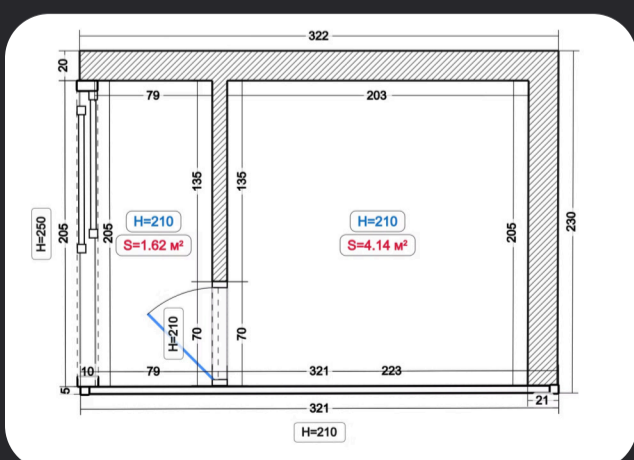

Basic plan

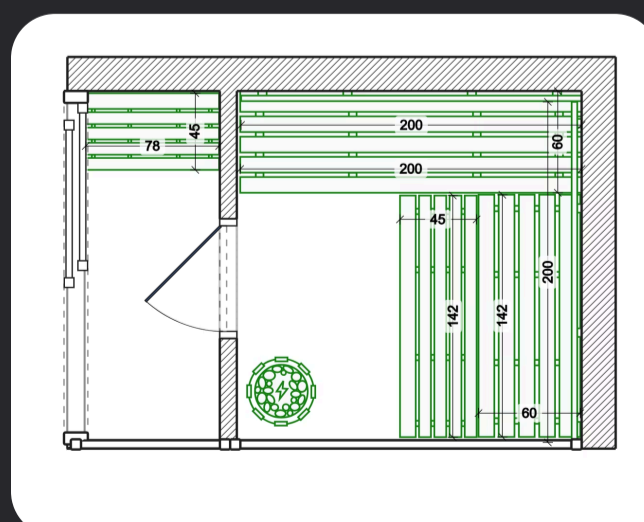

Layout of wooden furniture and the stove

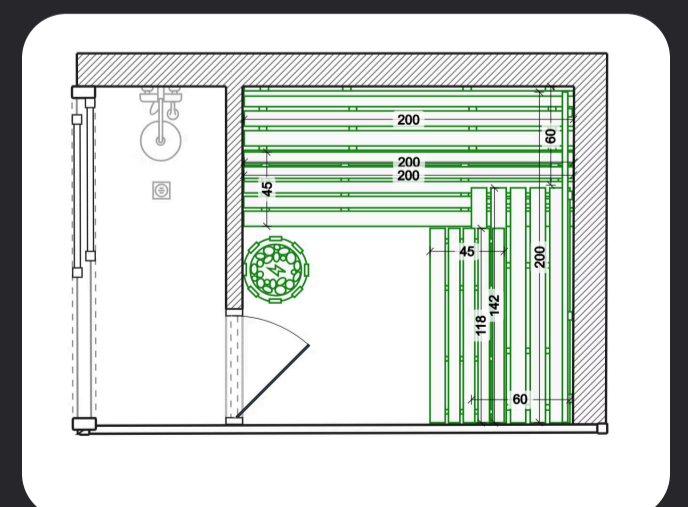

Layout of wooden furniture and the Shower system

Basic sauna price "HUB 322" - 11950 EURO (EXW Chisinau)

# Features and Model Options- "Hub 540"

**Hub 540** is the flagship model of the line, combining a spacious steam room and a separate relaxation room. It is an ideal choice for private residences, guest houses, and premium tourism objects. Key advantages: full relaxation zone; panoramic glazing; possibility of installing a shower system; premium finishing materials; increased level of comfort

Technical characteristics:

dimensions: 322 × 230 × 230 cm

weight: about 1500 kg

## Description of the sauna's basic equipment:

Metal frame, wooden battening, benches and interior walls made of lime wood, LED lighting of backrests and shelves, adjustable ventilation system, wooden floor slats for a comfortable stay, insulation—Sweetondale basalt wool (non-combustible)\PIR, facade glazing made of ESG safety glass 10 mm thick with a black enamelled frame, floor covering—porcelain stoneware, electric underfloor heating system (DEVI), sliding door system, panel with Himalayan salt, facade lighting. The wooden facade is treated with an antiseptic layer and two layers of facade lacquer from the manufacturer Renner (Italy).



Optionally, this model can be equipped with a shower system with a floor drain

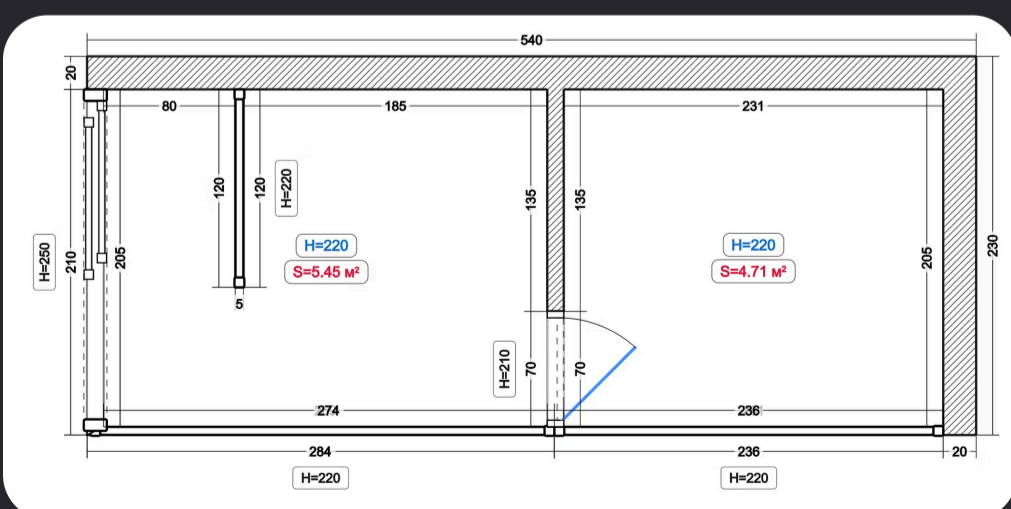

Basic plan

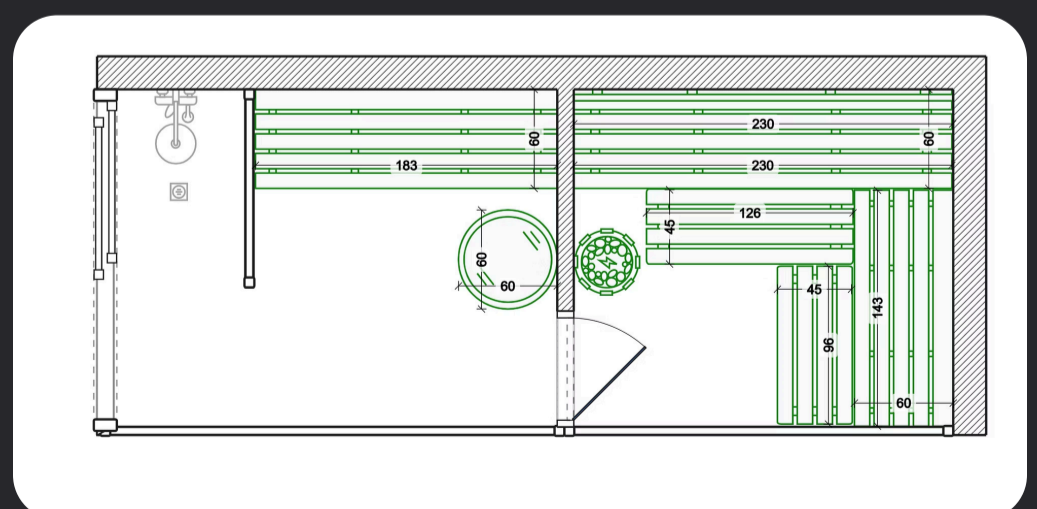











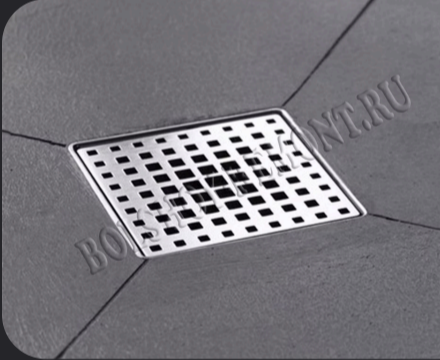

Layout of wooden furniture and the stove

Basic suna price "HUB 540"- 18800 EURO (EXW Chisinau)

# Unlock Ultimate Relaxation: Bespoke Sauna Upgrades

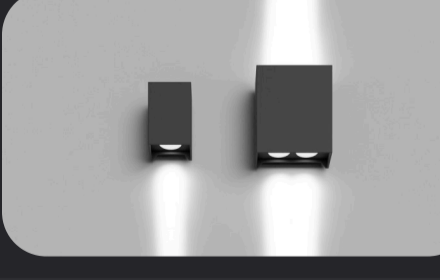
Curate your personal sanctuary. Our meticulously selected additional options transform your modular sauna into a bespoke haven of unparalleled comfort and exclusive well-being.

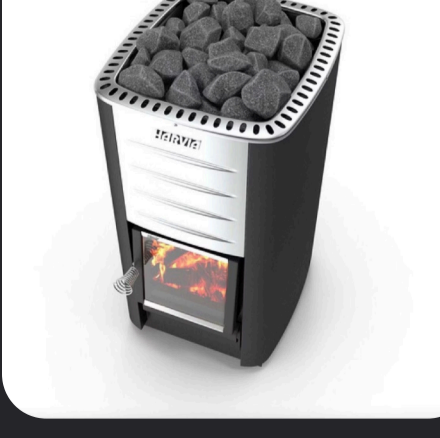
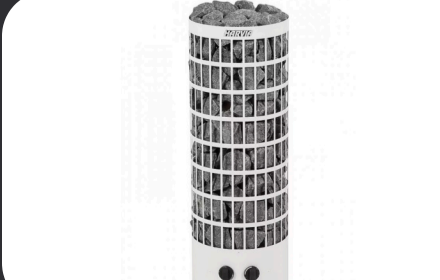
Himalayan Salt Wall with Integrated Backlighting (1 m 2 )	900 euros	
Advanced 'Second Breath' Air Circulation System	540 euros	
Premium Thermo-Aspen Interior Finish	680 euros	
Ergonomic Thermo-Aspen Benches	480 euros	
Aluminum Sliding Entrance Door System with Lock	750 euros	
Bronze/Gray Tempered Facade Glass (10 mm)	600 euros	
Mirror Tempered Facade Glass (8 mm)	1300 euros	
Thermo-Aspen Wooden Floor Drains	300 euros	
Integrated Floor Water Drainage	200 euros	
Invigorating Dousing Bucket & Cold Shower System	750 euros	
Efficient Water Heating System	450 euros	
Certified Chimney System for Wood-Burning Stoves	450 euros	
Enhanced Exterior Lighting (2 fixtures)	130 euros	
Integrated Underfloor Heating (Full Sauna Area)	600 euros	
Harvia M3 Black Wood-Fired Heater	800 euros	
Harvia Cilindro PC70 Steel Electric Heater (with built-in control)	680 euros	



## MOTO HUB: Luxury and Comfort for true connoisseurs of a comfortable life.

**Moto Hub** — Exclusivity and Comfort for true connoisseurs of a comfortable life! Moto Hub is not just a garage; it is a personal architectural space for a motorcycle that emphasizes the owner's style and turns the machine into part of the interior. Panoramic glazing makes the motorcycle a visual accent, and the thoughtful design ensures safety, order, and ease of use. Key features: panoramic glazing; warm contour; ventilation and lighting. Moto Hub is the choice of those who value aesthetics, order, and respect for their equipment

### Technical characteristics:

Dimensions: 322 × 230 × 230 cm;

weight: 1200 kg

### Description of basic equipment:

Porcelain stoneware floor, ventilation system, roller shutter system, LED lighting with **Soft ON** function, socket, optional underfloor heating system with a control display.



Module cost "MOTO HUB"- 10000 EURO (EXW Chisinau)